

# Alber

## CLC-200 CELLCORDER CONNECTION OPTIONS

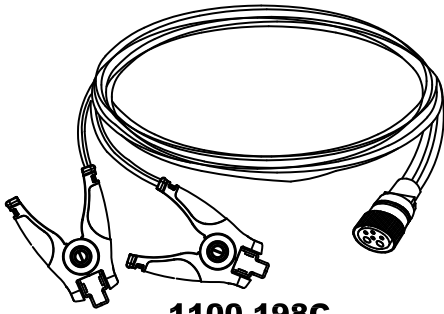

**1100-198C**  
Combined Leads  
(No Intercell)

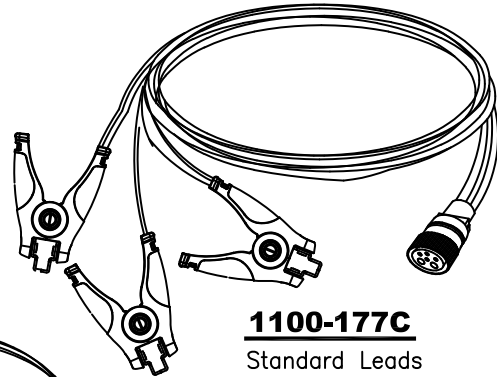

**1100-177C**  
Standard Leads

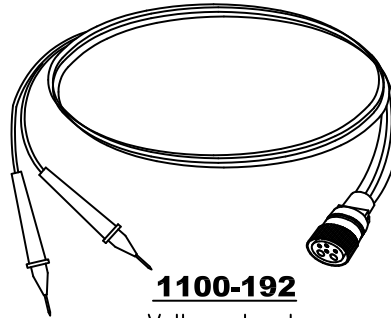

**1100-192**  
Voltage Leads

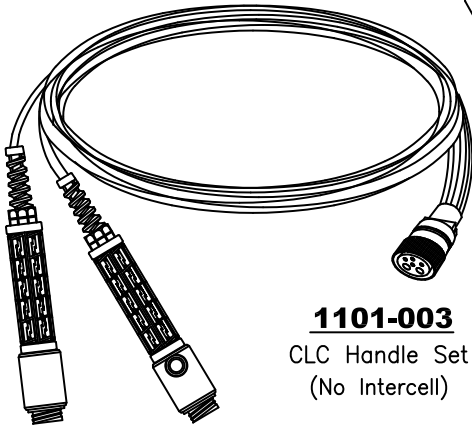

**1101-003**  
CLC Handle Set  
(No Intercell)

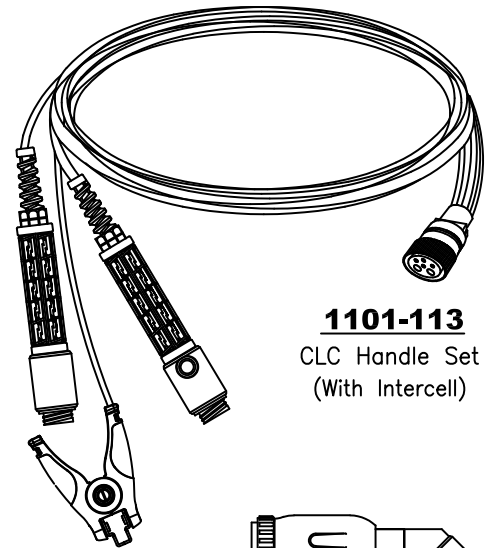

**1101-113**  
CLC Handle Set  
(With Intercell)

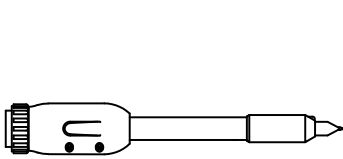

**1102-006**  
10" Straight Probe

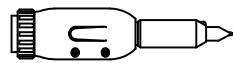

**1102-008**  
5" Straight Probe

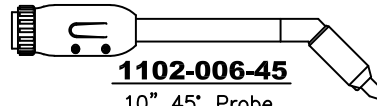

**1102-006-45**  
10" 45° Probe



**1102-008-45**  
5" 45° Probe

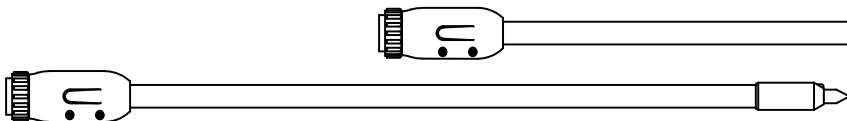

**1102-007**  
24" Straight Probe

**1102-007-45**  
24" 45° Probe

**SPIKE PROBES ARE SHOWN INDIVIDUALLY. EACH CRT HANDLE SET REQUIRES TWO SPIKE PROBES.**

For further information on which Cellcorder leads are best suited to your individual requirements, contact your local ALBER representative or ALBER directly at:

[www.alber.com](http://www.alber.com)

Phone (954) 623-6660

Fax (954) 623-6671

3103 N. Andrews Ave. Extension

Pompano Beach, FL 33064